

# PercussionPlay<sup>®</sup>

Outdoor Musical Instruments



# MUSIC MADE FOR THE GREAT OUTDOORS

Key:



Wheelchair  
Accessible



Suitable for concreting  
into the ground



Suitable for  
wall fixing

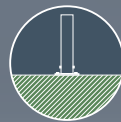

Suitable for  
surface fixing



Tethered paddles  
supplied



Tethered mallets  
supplied



Played with  
hands



Played with feet



# Music Made for the Great Outdoors

*Percussion Play offers cognitive, emotional, physical and inclusive play opportunities for everyone, everywhere.*

There is something special about music that crosses barriers and encourages closeness regardless of age, race, religion and background. Add in the therapeutic environment of nature and the great outdoors, and there are few things more enjoyable than musical play.

It is this sentiment, combined with over 20 years' experience in the play industry, that sits at the heart of Percussion Play. We strongly believe that outdoor musical instruments tick all the boxes, offering cognitive, emotional and physical play opportunities for everyone, everywhere.

Our instruments are easy to play for all ages and abilities and are either pentatonically tuned (for easy improvisation with no clashing notes), or diatonically tuned (so that the user can play familiar or favorite tunes as well as improvising or composing their own).

All of our instruments are handmade at our workshop in Hampshire, UK before traveling to play areas across the world. We take real pride in every piece we produce, creating durable instruments that are designed to stand the test of time and bring joy to all who play them.

Whether your outdoor area (or budget) is large or small we are sure you will find a suitable and exciting outdoor music solution within these pages.

# Knowledge Base

*“ It was like Christmas here the other day as we excitedly tore open boxes. The Sonora came out amazing. It’s stunning!”*

*Cape Cod Children’s museum*

Our online knowledge base is designed to help you find the information you need to create the perfect music park. It is full of relevant and compelling content such as:

- Case studies and testimonials from around the world.
- Free white papers on a multitude of music, play and health related topics.
- Best practice advice including guides to creating a sensory garden or outdoor music trail or playground.
- Our app containing videos of our instruments, data sheets and product-specific installation instructions.

Visit [www.percussionplay.com/knowledge-base](http://www.percussionplay.com/knowledge-base) for more and follow our social media for latest news, product innovations and events.

## Installation

We realize that installing your own instruments may seem a little intimidating but as well as being easy to play, our instruments are designed to be easy to install.

We assemble each product as far as possible before shipping and send clear, easy to follow installation instructions for each instrument.

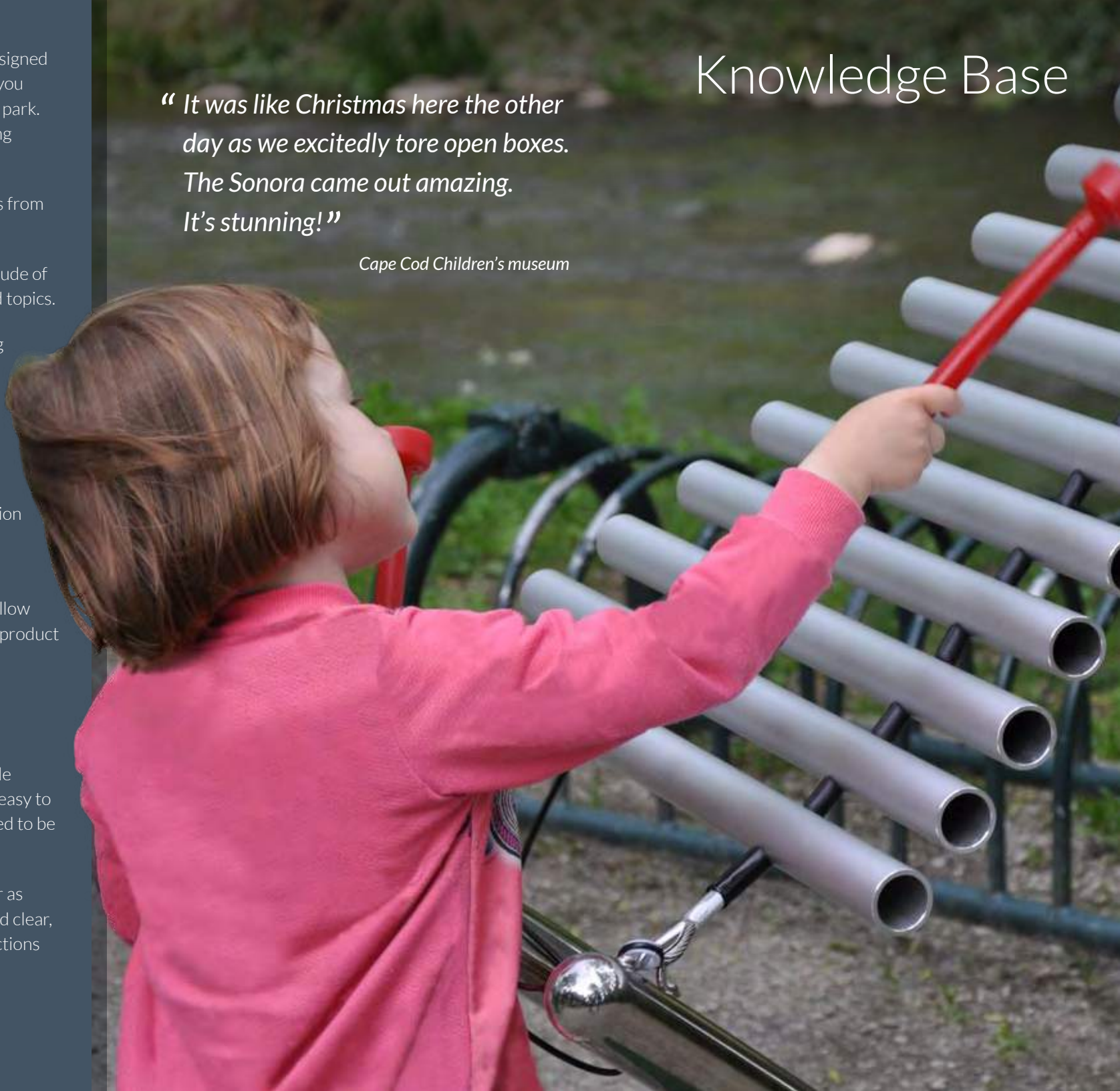

# Schools & Nurseries

Outdoor musical instruments present schools and nurseries with an excellent way of incorporating outdoor education into the day-to-day curriculum. They make creative, all-inclusive and accessible playground equipment and fantastic music education resources.

Children love the fact that music can be used in a context outside of the classroom. The instruments' clever design and the use of the pentatonic scale make them so easy to play that children are able to develop musical skills without having to manage any technical demands of traditional instruments, instantly showing what can be expressed and achieved through music.

Locating musical instruments in the school playground, outdoor performance area or perhaps a sensory garden where children can explore, create and develop their own musical ideas and sounds whilst enjoying the fresh air and sunshine, will maximize the musical potential of a child during their most rapid developmental period while they happily discover the joy and empowerment of music-making.

*“ Wanted to let you know that we  
LOVE our new musical instruments.  
They sound amazing!!! ”*

*Barretts Elementary School*

# Special Needs

*“We’re very happy!  
Staff working with  
pupils with more  
complex physical needs  
have reported that the  
instruments are great  
motivators during  
physio and OT work.”*

*Medina House,  
Community Special School*

Music can have a profound effect on anyone, but the benefits of exposing a child or adult with special needs to music can be huge.

Simple to play, our outdoor musical instruments enable creative experimentation and tactile exploration; they encourage the use of motor skills, help develop coordination and stimulate the imagination. For children with very limited movement, the placing of their hands on the vibrating lids of outdoor drums or along the Emperor Chimes, can elicit a positive response. Playing music may be an effective way to stimulate speech development and communication skills, express emotions and provide opportunities for physical, cognitive and motor development whilst creating an environment for socialization and fun.

Ideal for use during both music and occupational therapy sessions with their harmonic pentatonic scales and accessibility, outdoor musical instruments provide opportunities for children who experience physical or emotional obstacles in their lives to achieve security and joy in making music outdoors.



# Senior Care & Hospitals

*“ The musical instruments are a great success! They have encouraged the residents outside, to take longer walks, laugh, talk and socialize. ”*

*Aldersro Elder Centre, Director*



Nature and music are intimately connected and combining the therapeutic effects of being outdoors, along with the healing energy of music, can help to fuel the senses and become a welcome addition to the daily routine for seniors living in a care environment.

Our instruments provide opportunities for music-making for all adults regardless of musical experience and active music-making can be such a rewarding experience.

Playing music together creates a new and different way of communicating. It can help enhance sociability and create opportunities to forge and retain relationships. Music can also be effective in helping people connect across generational barriers. Intergenerational music-making with family members, other residents, visitors or carers will encourage fun and/or calming interactions between the ages.

Music for the young and young at heart!



# Parks & Trails

*“ Everyone is impressed  
with the instruments, their  
build quality and sound.”*

*Conner Prairie Interactive History Park, Indiana*

Outdoor musical instruments are perfect for parks, trails and recreation areas. Fully inclusive, accessible and multi-generational, our instruments make music-making possible for would be musicians of any age or ability.

Constructed from durable, easily cared-for materials, the instruments are low maintenance and require no safer surfacing. Whether in a small town or mega-city, they make original, unusual additions to any number of public outdoor spaces.

Our case studies, white papers and testimonials all confirm the benefits that music can bring to a community and how outdoor musical instruments in a park or open space provide opportunities to access music-making to people who may not otherwise be able to.

Musical instruments in outdoor community spaces engage people of all ages, cultures, and abilities. Music-making in the great outdoors brings people together in a way that few other activities can.



# Harmony Flowers

C5-A5



## Posy

Weight 18 kg / 40 lbs  
Width 63 cm / 25 in  
Depth 63 cm / 25 in  
Height 115 cm / 45 in

## Individual

Weight 8 kg / 18 lbs  
Width 28 cm / 11 in  
Depth 21 cm / 8 in

## Individual Height

C5 (red)	115 cm / 45 in
D5 (orange)	115 cm / 45 in
E5 (yellow)	100cm / 39 in
F5 (green)	100cm / 39 in
G5 (blue)	85 cm / 33 in
A5 (indigo)	85cm / 33 in





Minor Posy (D5 F5 A5)



Major Posy (C5 E5 G5)



G5



C5

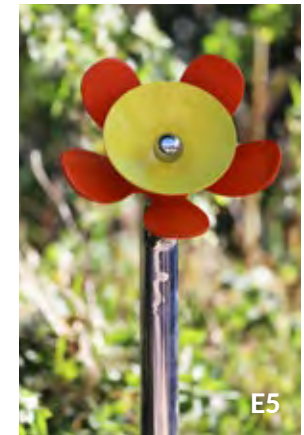

E5



D5



A5

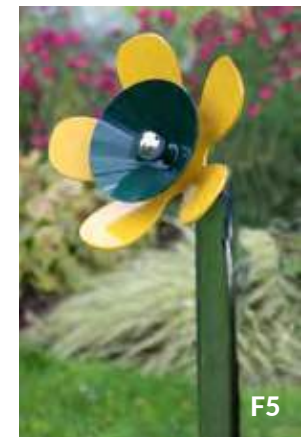

F5

A bouquet of six cheerful and eye-catching musical flowers. Available individually or in two posy arrangements – you can collect them all and watch your musical garden grow and bloom.

Each flower is made of a stainless-steel frame with powder-coated aluminum flower petals and bells in six different color combinations. Strike the ‘bell’ to make it chime.

Show your park, playground or outdoor space some love with these bright and colorful musical flowers.



# Harmony Bells

## Bunch

Weight 26 kg / 57 lbs  
Width 120 cm / 47 in  
Depth 120 cm / 47 in  
Height 165 cm / 65 in

## Individual

Weight 10 kg / 15 lbs  
Width 28 cm / 11 in  
Depth 55 cm / 22 in

## Individual Heights

C Major (red) 150 cm / 60 in  
F Major (green) 165 cm / 65 in  
G Major (blue) 135 cm / 53 in  
D Minor (orange) 135 cm / 53 in  
E Minor (yellow) 150 cm / 60 in  
A Minor (indigo) 165 cm / 65 in





Minor Bunch (All three minor bells)



Major Bunch (All three major bells)



A Minor



F Major



E Minor



C Major



G Major

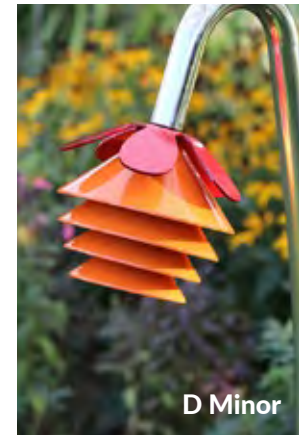

D Minor

Perpetually in a perfect state of bloom, Harmony Bells are suitable for many different outdoor locations and will withstand all weather conditions and seasons.

Each flower is made of four bells of decreasing size and ascending pitch. Each 'bell' - when struck - emits a pure tone with a long sustain.

Available individually or in a 'bunch' of three bells in complementary chords. Ideal for interactive playscapes, they'll arouse a sense of intrigue and encourage participants into the pursuit of music-making in the great outdoors.



# Petal Drums



## Daisy

Weight 24 kg / 53 lbs  
Height 108 cm / 42.5 in  
Width 56 cm / 22 in  
Depth 62.5 cm / 24.5 in

## Sunflower

Weight 24 kg / 53 lbs  
Height 108 cm / 42.5 in  
Width 56 cm / 22 in  
Depth 62.5 cm / 24.5 in

## Forget-Me-Not

Weight 24 kg / 53 lbs  
Height 106 cm / 42 in  
Width 56 cm / 22 in  
Depth 61 cm / 24 in

## Poppy

Weight 24 kg / 53 lbs  
Height 108 cm / 42.5 in  
Width 54 cm / 21 in  
Depth 62 cm / 24.5 in

We've expanded our botanically inspired range by taking our sweet-sounding stainless steel Babel Drum and giving it a floral makeover.

Each 'Petal Drum' contains a small (10"/250mm) Babel Drum encased with shaped aluminum 'petals', securely mounted to a stainless-steel frame.

Shop for individual flower drums or get creative and create your flower arrangement by choosing from a Forget-Me-Not, Sunflower, Poppy, or Daisy.

Adding a hint of happy to any space, Petal Drums look and sound gorgeous on their own or with any combination of our instruments. A smart choice to quickly and simply add another dynamic to your outdoor space or playground.



### Daisy Petal Drum

Tuning = A-Minor (A-C-D-E-G-A)

Sporting white aluminum petals and classic yellow center – always sunny and cheerful – this Daisy with its happy notes will guarantee smiles all round.

### Forget-Me-Not Petal Drum

Tuning = C-Major (C-D-E-G-A-C)

Vivid-blue aluminum petals with central yellow babel drum - Forget-Me-Nots are linked to memory and remembrance and the recognized emblem for dementia organizations.

### Poppy Petal Drum

Tuning = A-Akebono (A-B-C-E-F-A)

A flower that represents so much. With its classic red petals and central black drum, this Poppy will stand out both in look and sound - a sure-fire way to make a lasting impression.

### Sunflower Petal Drum

Tuning = C Pygmy (C-D-Eb-G-Bb-C)

Bright, yellow aluminum petals and central black babel drum - this cheerful 'Sunflower Drum' will turn heads and add sunshine to your outdoor space.



# Small Babel Drum

C Major Pentatonic - C4-C5



Weight 17 kg / 37 lbs  
Width 40 cm / 16 in  
Height 98cm / 39in

Babel Drums are circular stainless-steel tongue drums fixed for permanent outdoor installation which produce calming and hypnotic sounds.

Available in two sizes, both offer a unique hand-drumming experience with no mallets required. You can also order a small soft mallet specifically designed to accompany these instruments, for those with restricted hand or finger movement.





The large Babel Drum, with an eight-note layout, is very melodious - producing full, rich, meditative sounds with bountiful sustain and overtones.

No previous drumming experience is required to play a Babel Drum and both children and adults will enjoy improvising with the mesmerizing sounds they produce. Never too brassy or too loud - perfect for musical exploration and sensory play in the fresh air.



# Large Babel Drum

G Major Pentatonic - G3-B4

Weight	21 kg / 46 lbs
Width	51 cm / 20 in
Height	98cm / 39in



# Cajon

Unpitched Percussion

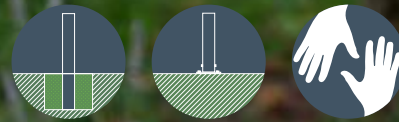

Cajons are perfect for outdoor performances. Durable, responsive, and easy to play, they have an in-built snare at the top and a low bass sound around the middle, suitable for many different styles of music.

Inspired by the traditional Cuban and Peruvian Cajon drums, our versions have a resonating box made from stainless steel, making them ideal for year-round outdoor use. With no moving parts or attachments, these outdoor drums are perfect for street scenes and less supervised areas.

Cajons are available individually, in a set of three or as a deluxe version.

Each is attractive, sturdy, and can double up as a seating solution; several Cajons together form the perfect drum circle.

Weight 20 kg / 44 lbs  
Width 28 cm / 11 in  
Depth 36 cm / 14 in  
Height 41 cm / 16 in

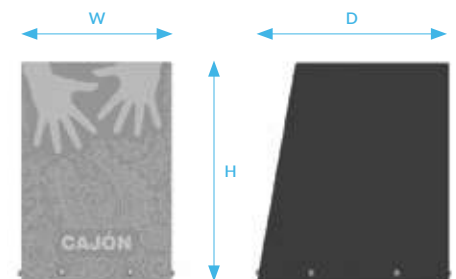

# Cajon Drum Circle

(set of three)

Cajon Drum Circles require no previous drumming experience – everyone can participate and enjoy this fun and vibrant sound adventure. Players can quickly develop a common language through playing and listening together.

# Cajon Deluxe

The Cajon Deluxe includes a thick solid hardwood 'seat' with mahogany look finish to provide a soft and warm feeling when seated to guarantee a comfortable and enjoyable playing experience.



# Tumbadoras

Unpitched Percussion



Weight 26 kg / 57 lbs  
Width 63 cm / 25 in  
Depth 30 cm / 12 in  
Height 85 cm / 33 in

Made from stainless-steel for a contemporary look and awesome sound, the Tumbadoras make a great choice for any number of outdoor settings.

A set includes a pair of tumba drums mounted on a single stand, so you can have a comfortable playing experience that is both fun and easy.

Practice your skills on these and they will deliver marvelous bass notes with deep resonance and high-pitched cutting slap sounds.



We've taken the traditional African conga drum and added our own twist to bring its deep, soft sound to the great outdoors.

Mounted onto a stainless-steel post, these colorful drums sound as good as they look.

Our Congas are available as a trio of pairs or as individual pairings in small, medium and large - each in different colors and producing different tones.

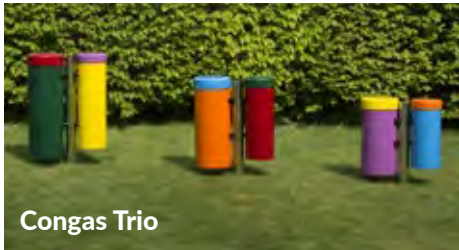

Congas Trio



Small Congas

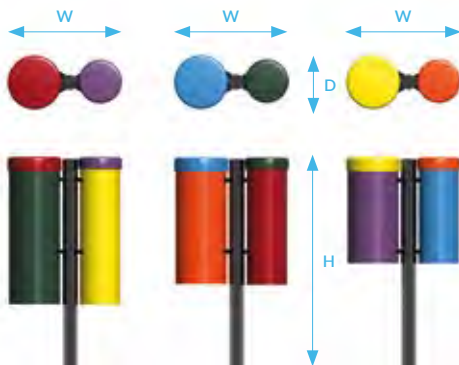

Weight	13-15 kg / 29-33 lbs
Width	56 cm / 22 in
Depth	26 cm / 10 in
Max Height	86 cm / 34 in

# Congas

Unpitched Percussion



Small Congas

# Djembes

Unpitched Percussion



With their distinctive goblet shape, Djembes make a wonderful addition to a music park, trail or urban space.

The large head size allows multiple beats from low to high with players able to create unique and versatile sounds by hitting or slapping the different areas of the Djembe's head with their hands.

The stainless-steel body makes this a smart choice for urban environments - delivering high-class performance and featuring robust construction for enhanced durability.

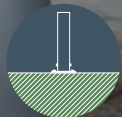

Weight	50 kg / 110 lbs
Width	25-35 cm / 10-14 in
Min Height	60 cm / 24 in
Max Height	85cm / 33in

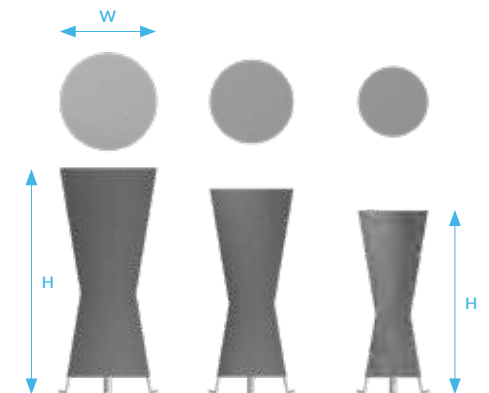

This eye-catching set of five outdoor drums is one of our most popular products. Fun and easy to play, the Rainbow Sambas will shape a love of music, beat and rhythm. Played with just your hands, soft yet satisfying sounds can be made whatever your age.

The unique tones produced make Sambas perfect outdoor play equipment that are also well suited to music lessons, outdoor school performances, drumming and music therapy sessions. Sambas are available in our standard rainbow colors.



# Rainbow Sambas

Unpitched Percussion

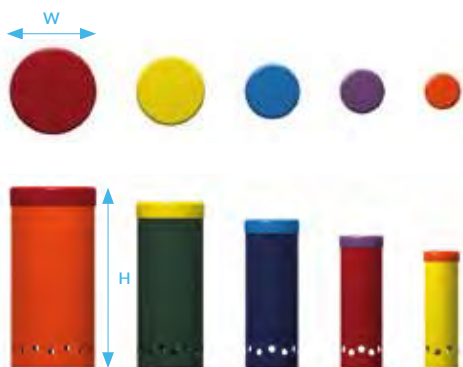

Weight	45 kg / 99 lbs
Width	16-40 cm / 6-16 in
Min Height	55 cm / 23 in
Max Height	85cm / 34 in

# Calypso Chimes

C Major C4-C5  
Diatonic (8 Notes)  
Pentatonic (6 Notes)  
Quartet (C4,E4,G4,C5)

Imagine stumbling across the colorful world of Carnival when visiting the local park! These vibrant anodized aluminum rainbow-colored Calypso Chimes are individually mounted to stylish stainless-steel posts complete with mallet and holder. Each note produces a clear lively tone with a long sustain when struck.



Weight	8 kg / 18 lbs
Width	14 cm / 5.5 in
Depth	11 cm / 4.5 in
Height (L)	120-151 cm / 47-59 in





With four rainbow colored aluminum chimes with heavy duty anodized finish mounted onto a bright, easily maintained stainless-steel post - the Calypso Quatro Post with its modern and attractive appearance is sure to keep the carnival vibes going!

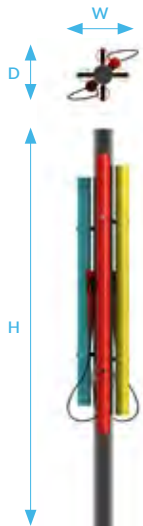

Weight	12 kg / 26 lbs
Width	21.5 cm / 8.5 in
Depth	21.5 cm / 8.5 in
Height (L)	151 cm / 59.5 in

# Calypso Quatro Post

C4 E4 G4 C5



# Penta Post

C Major Pentatonic - C5-C6

Small and compact, the bright and appealing Penta Post is a cluster of five rainbow colored chimes attached to a single stainless-steel post.

Tuned to the pentatonic scale, the Penta Post makes a perfect music 'stop' for pre-schools and early years settings, encouraging creativity and developing hand strength and dexterity.



Weight 11 kg / 24 lbs  
Width 20 cm / 8 in  
Height 115 cm / 46 in

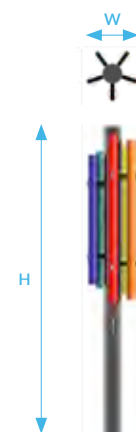

These bright and inviting Rainbow Bongo drums are easy to securely fix into the ground, to a wall or to a post - and suitable for both indoor and outdoor use.

Perfect for nursery schools, pre-schools and kindergartens, these space-saving Bongos are a great way to introduce drumming and rhythm to toddlers and young children with lots of energy!

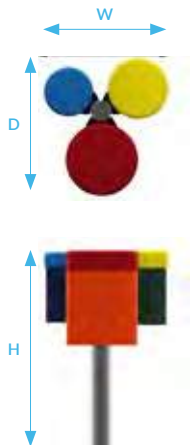

# Rainbow Bongos

Unpitched Percussion



Weight	12 kg / 26 lbs
Width	42 cm / 17 in
Depth	47 cm / 19 in
Height	85 cm / 34 in



# Rainbow Chimes

C Major Pentatonic  
C5-C6



Perfect for nursery schools, pre-schools and kindergartens, these bright and inviting small-scale Rainbow Chimes are a wonderful instrument to get young children interested and excited about music.

The harmonious pentatonic notes are ideal for developing a sense of rhythm and coordination in children. Easy to securely fix in the ground, or to a wall, fence or post and suitable for both indoor and outdoor use, these inclusive Rainbow Chimes encourage creativity and musical exploration.

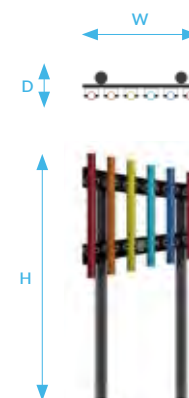

Weight	12 kg / 26 lbs
Width	70 cm / 27 in
Depth	16 cm / 6.5 in
Height	146 cm / 57.5 in

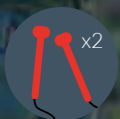

This small-scale Rainbow Metallophone is a pentatonically tuned instrument and a great way to foster musical development in young children.

Bright and inviting, the Rainbow metallophone is easy to securely fix in the ground, a wall or post and suitable for both indoor and outdoor use.

Ideal for improving hand to eye coordination, rhythm, and fine motor skills, this small and compact instrument will give children an opportunity to improvise and compose their own melodies.



# Rainbow Metallophone

C Major Pentatonic - C5-C6

Weight	14 kgs / 31 lbs
Width	32 cm / 12 in
Depth	37 cm / 14 in
Height	90 cm / 36 in

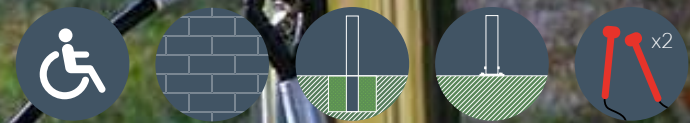

# Cavatina

C Major Diatonic - C4-C6

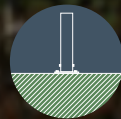

The Cavatina is a most appealing instrument both in the way it looks and in the beautiful sounds it offers. Diatonically tuned, its versatility provides a vast range of expression suited to beginners and experienced musicians alike, performing in even the most challenging outdoor environments.

The rainbow-colored anodized aluminum notes are set to our rainbow scale and can be combined with one of our Music Books where the notes on the instrument correspond with the colored notes on the music sheets. Players then simply follow the colors to play a well-known song.



Weight	27 kg / 60 lbs
Width	75 cm / 30 in
Depth	55 cm / 22 in
Height	94 cm / 37 in

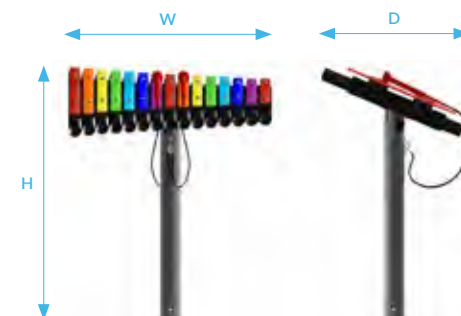

Our Cadenza is a small yet captivating instrument with a curved design and arranged as a traditional xylophone. Perfect for exploring possibilities with melody, harmony and rhythm.

The Cadenza can be adapted to any outdoor setting. It can be ground or surface installed, or in cases where space is limited, it can be wall mounted.

Available as standard with aluminum notes, the Cadenza is also available on request with GRP notes in the color of Purple Heart wood. Each note material gives its own distinct sound when played.

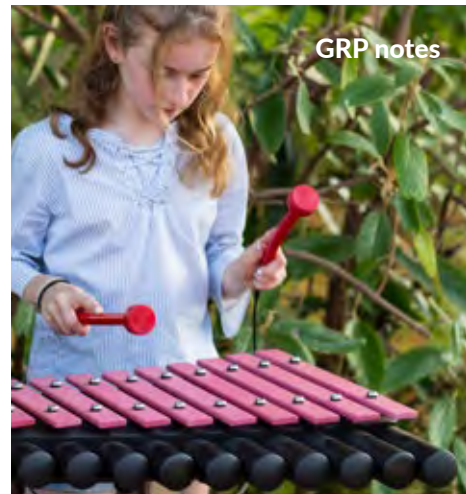

GRP notes

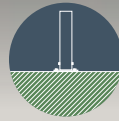
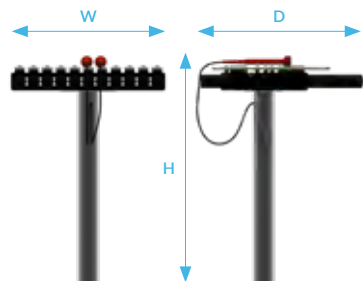

Weight	22 kg / 49 lbs
Width	58 cm / 23 in
Depth	58 cm / 23 in
Height	85 cm / 34 in

# Cadenza

C Major Pentatonic - C4-C6



Aluminum Notes

# Music Book

The Music Book is designed to accompany the Cavatina or Capella using our rainbow scale and is a permanent installation.

Each note on the Capella and Cavatina is anodized to a brilliant, bright color that coordinates with the music sheets. The player simply follows along with the colors to play a well-known song.

The Music Book offers a variety of different tunes and is available with two music sheets (four songs) or four music sheets (eight songs). It also provides an excellent introduction to learning to read music.

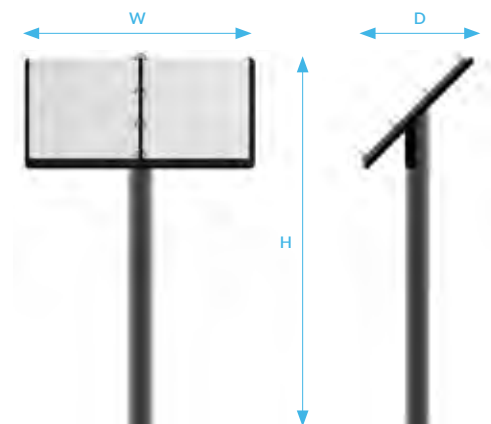

Weight	22 kg / 49 lbs
Width	59cm / 24 in
Depth	29cm / 12 in
Max Height	118cm / 46 in





The Capella Diatonic Xylophone has 15 Rainbow colored notes and its diatonic arrangement allows players to play lots of familiar songs or compose their own.

The vibrantly colored anodized notes are set to our rainbow scale and can be combined with one of our Music Books for players to simply follow the colored notes to play a well-known song.

Set on an HDPE mounting, the stainless-steel resonators will deliver a bright, rounded sound.

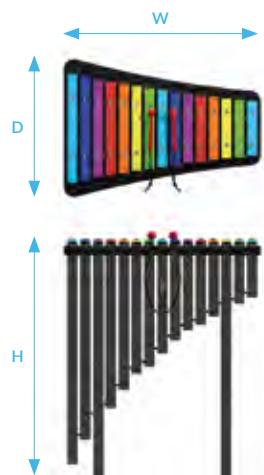

Weight 45 kg / 99 lbs  
Width 76 cm / 30 in  
Depth 54 cm / 21 in  
Height 95 cm / 37 in



# Capella

C Major Diatonic - G3-G5

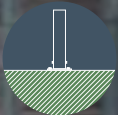

# Duo

C Major Pentatonic - C4-C6



Weight 43 kg / 95 lbs  
Length 110 cm / 43 in  
Depth 85 cm / 34 in  
Height 85 cm / 34 in

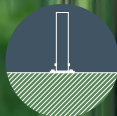

Cupla

Designed originally to benefit people with autism, the easily accessible Duo allows you to play an instrument with someone else while remaining in your personal space and without the added pressure of making eye contact. The Duo is distinctive and unique as it encourages social interaction and self-expression while being an inviting focal point in any outdoor setting.

The Duo is built as standard with half aluminum notes and half GRP notes in the color of purple-heart wood. Each of these materials gives a distinct sound when played.

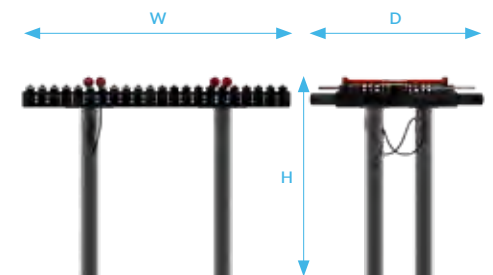

Sansa-Rimba is a clever blend of two African instruments; the Sansa (thumb-piano) and a Marimba (xylophone) with its 15 notes ascending from the center outwards.

Just as fitting in a school playground or music trail as it would be nestled in a care home garden, this compact instrument is easy to play and a perfect introduction to musical exploration and improvisation.

Sansa-Rimbans are built as standard with plain aluminum notes but also available with our popular anodized rainbow-colored notes.

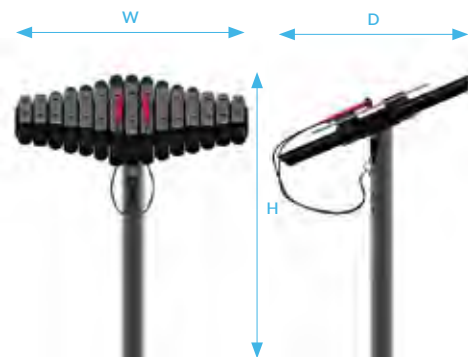

# Sansa-Rimba

C Major Diatonic - C4-C6



Weight	28 kg / 62 lbs
Width	75 cm / 30 in
Depth	68 cm / 27 in
Height	96 cm / 38 in

# Bell Lyre

Unpitched Percussion



Our Bell Lyre is made of 8 graduated stainless-steel bells presented within a beautiful contemporary stand reminiscent of a lyre.

Easy to play for all ages and abilities, the bells 'sing' when struck with the attached pair of mallets.

With an easy single post installation, the Bell Lyre is a low maintenance, calming addition to any outdoor setting and a charming statement piece.



Weight 25 kg / 55 lbs  
Width 75 cm / 30 in  
Depth 24 cm / 9 in  
Max Height 190 cm / 75 in

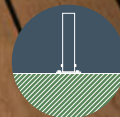

The Cherub's 11 tubular bells are made from hand tuned, heavy duty anodized aluminum and produce a clear, bright sustaining tone when struck.

The Cherub can be wall mounted or affixed to posts for easy installation.

With elegant and healing sounds, the Cherub is the perfect inclusive addition to sensory gardens in special needs environments, hospitals, nursing homes, schools or community spaces.

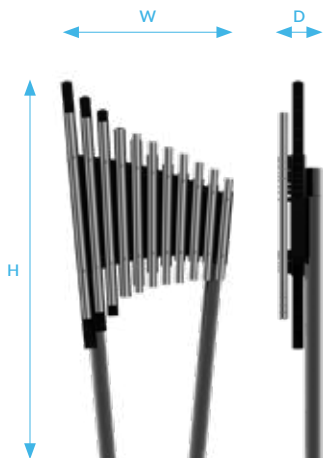

# Cherub

C Major Pentatonic - C4-C6

Weight	42 kg / 93 lbs
Width	71 cm / 28 in
Depth	20 cm / 8 in
Max Height	170 cm / 67 in



# Emperor Chimes

C Major Pentatonic - C3-C4

C Major Triad - C3, E3, G3

Emperor Chimes are the ultimate in outdoor musical chimes. They should be played gently with fingertips or the palms of the hand.

With the largest chime standing over 2.5m (8ft) in height, these chimes are available in a full pentatonic set of six or in a harmonic group of three.

Because they are played by hand, they produce soft, velvety rich tones with an excellent sustain.

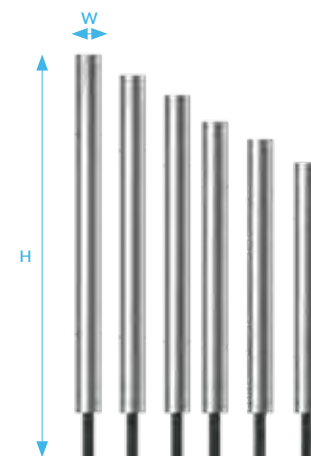

Weight	117 kg / 258 lbs
Width	13 cm / 5 in
Min Height	179 cm / 70 in
Max Height	249cm / 98 in



Colossus Chimes are a supreme set of outdoor musical chimes for all ages to enjoy.

Combining the full pitch range of our Tubular Bells and Emperor Chimes, this all-encompassing sound sculpture delivers a heightened musical experience that you can feel as well as hear as the chimes vibrate and resonate long after you strike them with the mallets.

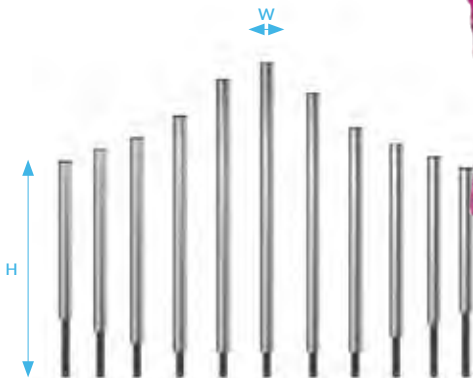

# Colossus Chimes

C Major Pentatonic - C3-C5

Weight	136 kg / 300 lbs
Width	10 cm / 4 in
Min Height	156 cm / 61 in
Max Height	235 cm / 93 in

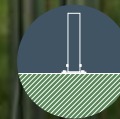

# Freechimes (Pentatonic)

C Major Pentatonic - C3-C6

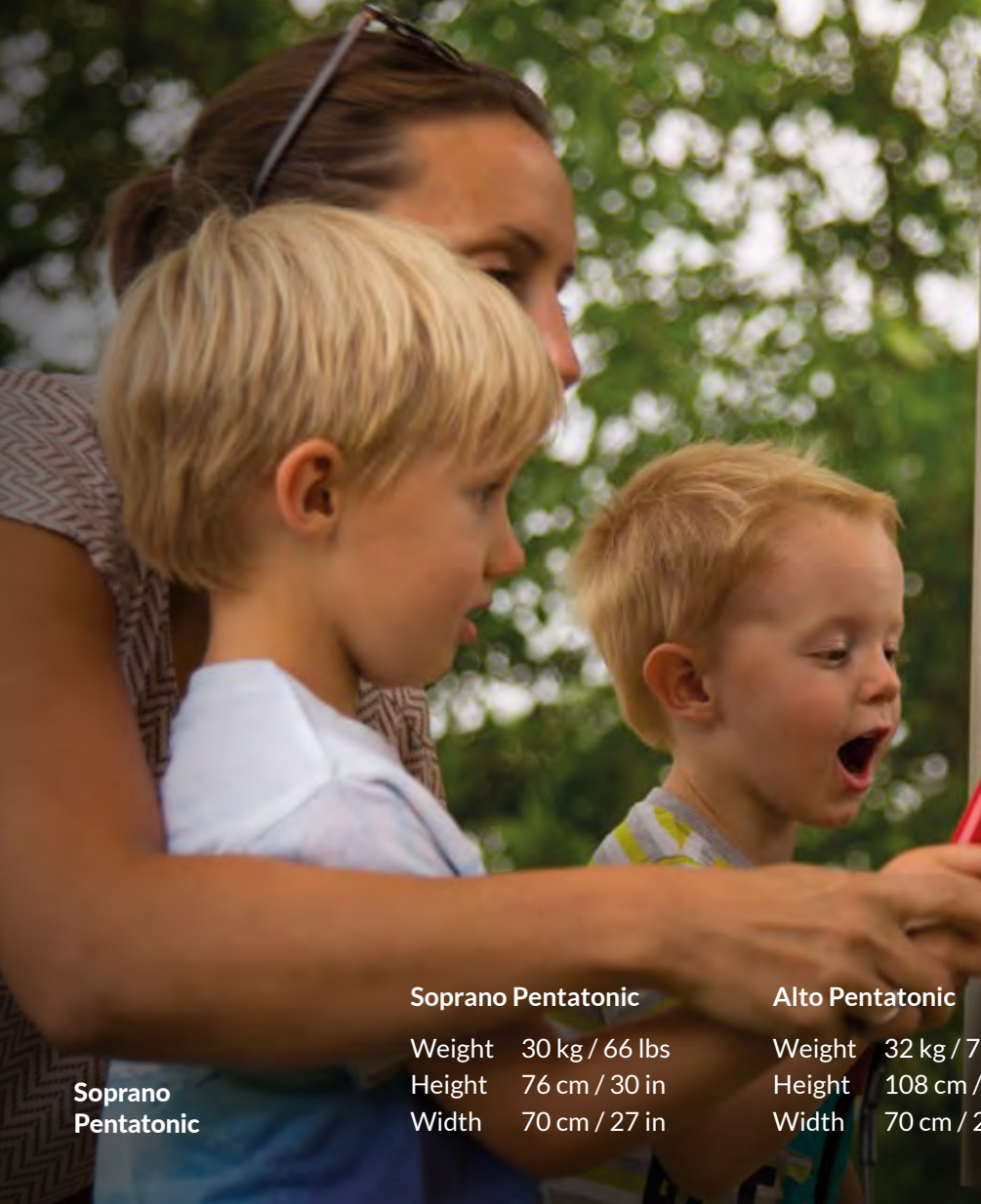

Freechimes are practical, durable and stylish with a beautiful melody and sustain that will liven up any outdoor area.

Easy to install, easy to play and easy to maintain, Pentatonic Freechimes make the perfect addition to inclusive and accessible playgrounds and outdoor spaces. The beauty of the pentatonic scale is that there are “no wrong notes”. Just striking the chimes randomly produces a harmonious melody.

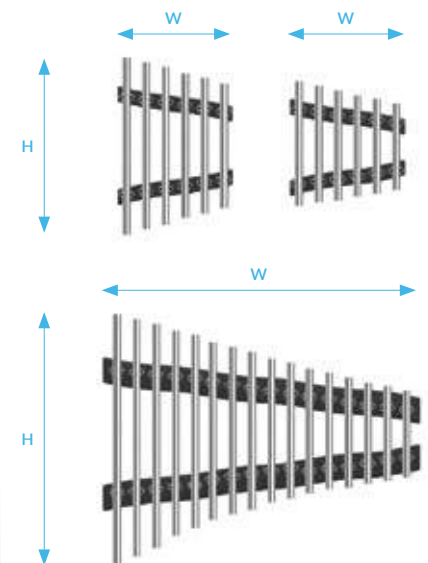

## Soprano Pentatonic

Weight 30 kg / 66 lbs  
 Height 76 cm / 30 in  
 Width 70 cm / 27 in

## Alto Pentatonic

Weight 32 kg / 71 lbs  
 Height 108 cm / 42 in  
 Width 70 cm / 27 in

## Symphony Pentatonic

Weight 54 kg / 119 lbs  
 Height 153 cm / 60 in  
 Width 192 cm / 76 in

**Soprano  
 Pentatonic**



A diatonic arrangement of Freechimes is great for schools, outdoor classrooms and music therapy. The accurately tuned notes resemble the diatonic scale of a piano keyboard - offering a great way to start learning music in a fun and informal way.

Available individually, in pre-set arrangements or as full symphonies, Freechimes have an outstanding resistance to vandalism and all weather conditions - making them the perfect addition to a sensory garden or music trail.

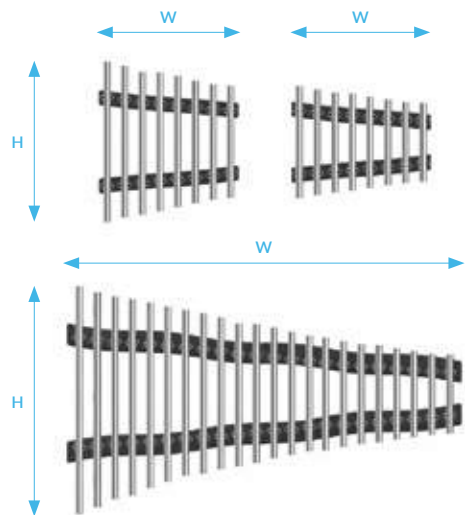

**Soprano Diatonic**

Weight 34 kg / 75 lbs  
 Length 76 cm / 30 in  
 Width 93 cm / 37 in

**Alto Diatonic**

Weight 37 kg / 82 lbs  
 Length 108 cm / 42 in  
 Width 93 cm / 37 in

**Symphony Diatonic**

Weight 66 kg / 146 lbs  
 Length 153 cm / 60 in  
 Width 264 cm / 104 in

**Symphony Diatonic**

# Freechimes (Diatonic)

C Major Diatonic - C3-C6

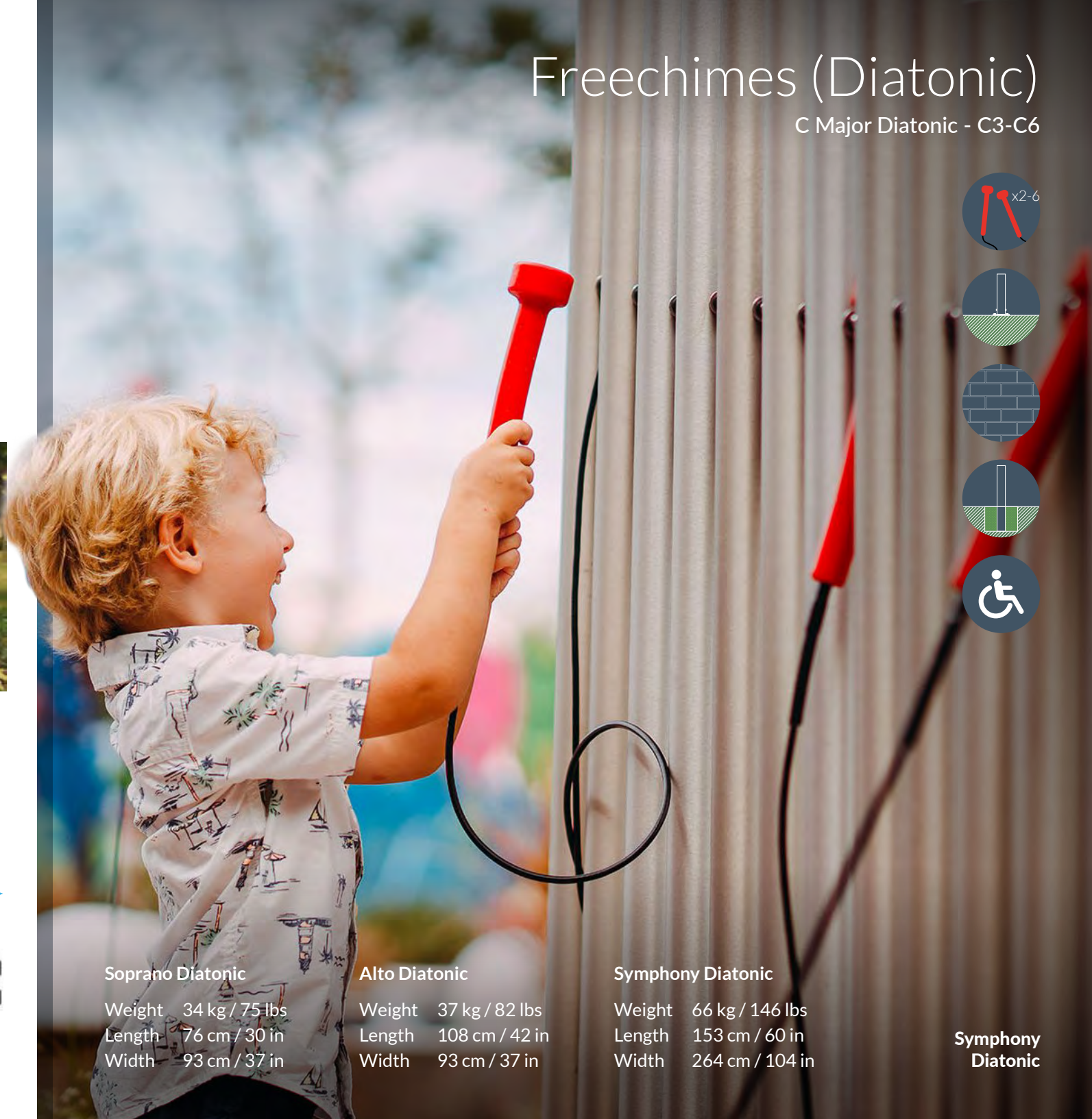
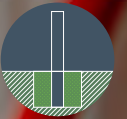
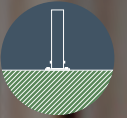

# Harmony

C Major Pentatonic - C5-C7



The Harmony is based upon a traditional Vietnamese Bamboo xylophone called a T'rung.

Elegant, with an irresistibly beautiful sound and resonance, the Harmony is perfect for exploring melodies. The harmonic arrangement of notes produces a sweet and happy high pitched sound when played.



Weight	22 kg / 49 lbs
Width	70 cm / 28 in
Depth	89 cm / 35 in
Max Height	139cm / 55 in

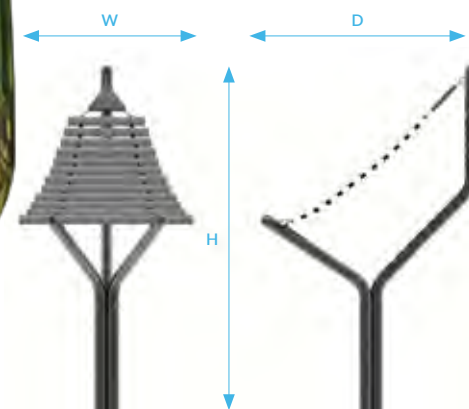

Our Wall Marimba combines musical creativity with space-saving efficiency.

The fifteen diatonic C Major C4-C6 notes are made from polished GRP designed to look like Purple Heart hardwood which creates a distinctly happy sound.

Wall mounted outdoor musical instruments such as the Wall Marimba provide the perfect solution to liven up a difficult or overlooked area and work well in areas where there is limited space available such as courtyards, covered patios and other outdoor structures or classrooms.



# Wall Marimba

C Major Diatonic - C4-C6

Weight	14 kg / 31 lbs
Width	151 cm / 59 in
Depth	13 cm / 5 in
Max Height	50 cm / 20 in



# Mirror Chimes

C Major Pentatonic - C4-C6



Weight	20 kg / 44 lbs
Width	132 cm / 52 in
Depth	13 cm / 5 in
Max Height	109 cm / 43 in



Our beautiful Mirror Chimes will reflect light and add intrigue to your outdoor space.

The highly polished durable stainless-steel notes add a touch of sparkle while remaining extremely durable. Assembled using universal mounting brackets which can be used on virtually any vertical surface.

Mirror chimes are pentatonic, allowing players to produce relaxing melodies that reflect harmony, grace and beauty.

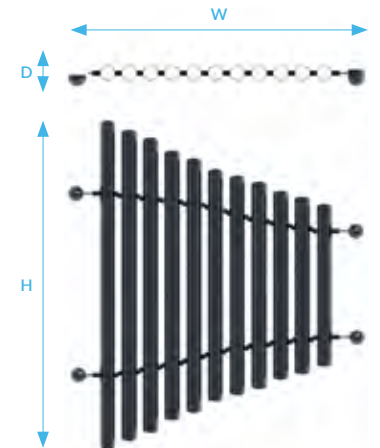

# My Tunes

Composed

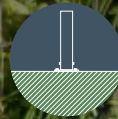

My Tunes are a unique concept and great fun to play for all ages. Anodized aluminum notes are suspended between stainless-steel posts and arranged sequentially so that by simply striking the notes in order a familiar tune is played.

Choose from well-known favorite songs or personalize to suit the instrument's location or target audience. Some examples of our My Tunes projects to date include:

- Star Spangled Banner
- Teddy Bear's Picnic
- Grand Old Duke of York
- Old MacDonald had a Farm
- I Do Like to Be Beside the Seaside
- Frère Jacques
- Amazing Grace
- Darling Clementine
- Ode to Joy
- O Canada

Weight Varies  
Width Varies  
Depth 8 cm / 3 in  
Max Height 136 cm / 54 in

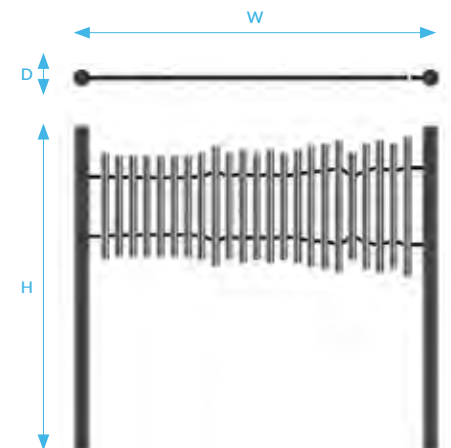

The Sonora's 21 tubular bells produce a tone that is bright, clear, and resonant. Made from hand-tuned, heavy duty anodized aluminum, the Sonora can be wall-mounted or affixed to posts for easy installation in any location.

Its elegant shape, based on a wave effect, has a visual appeal that makes the Sonora ideal for use in attractions such as museums, zoos, and heritage sites as well as community projects or music therapy.



# Sonora

C Major Pentatonic - C4-C6

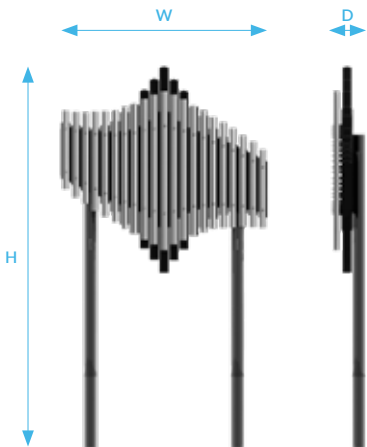

Weight	57 kg / 126 lbs
Width	118 cm / 47 in
Depth	20 cm / 8 in
Height	170 cm / 67 in



# Papilio Bells

C Major Pentatonic - C4-C7

Weight 45 kg / 99 lbs  
Width 245 cm / 96 in  
Depth 81 cm / 31 in  
Height 111 cm / 43 in

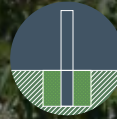

Papilio - with a name derived from the resemblance of its elegant shape to that of the Butterfly - is a tubular bell type metallophone with notes of suspended anodized aluminum tubes supported by a stainless-steel frame.

The wide span of the Papilio means it can easily be played by 4 players - an opportunity for people of all ages to play alongside each other, plus the pentatonic nature of the instrument means there are no wrong notes.

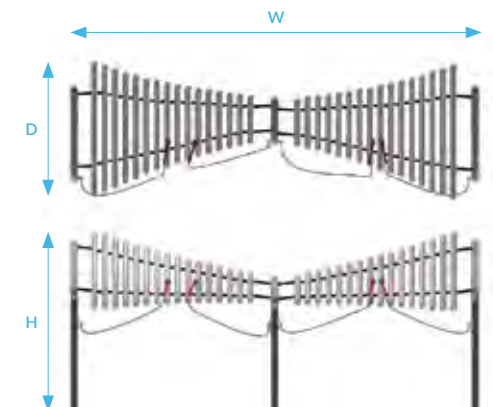

Where music meets art. The Tutti is an eye-catching, three-sided sound sculpture, best played with a couple of friends.

Made from three different materials, aluminum, glass-reinforced plastic (GRP) and Paduak hardwood, set into a stainless-steel stand, the Tutti has a variety of tones that work when played individually or collectively as one super-instrument.

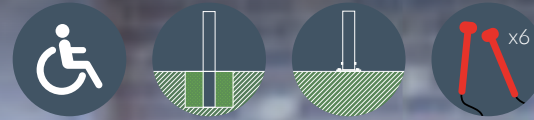
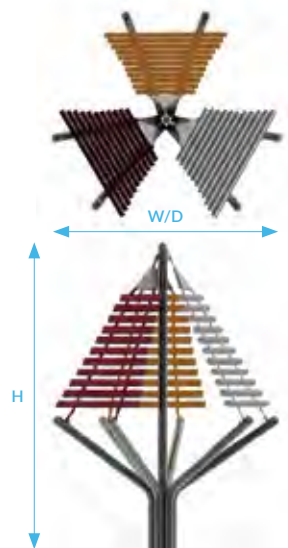

# Tutti

Aluminum - C5-C7 Pentatonic  
 Paduak - A3-A5 Pentatonic  
 GRP - G3-C5 Diatonic

Weight 60 kg / 132 lbs  
 Width 130 cm / 51 in  
 Depth 130 cm / 51 in  
 Height 155 cm / 61 in

# Tubular Bells

C Major Pentatonic - A3-C5



Tubular bells are a visual and sonic delight for all ages.

The mid-range tone is not only heard but felt too. Simple yet striking, these bells will bring an architectural dynamic to your chosen outdoor area, as well as an amazing auditory experience.

Available as a set of 7 or individually. We recommend that they are installed in a horseshoe arrangement, so that when inside the curve you are literally 'bathed in sound'.

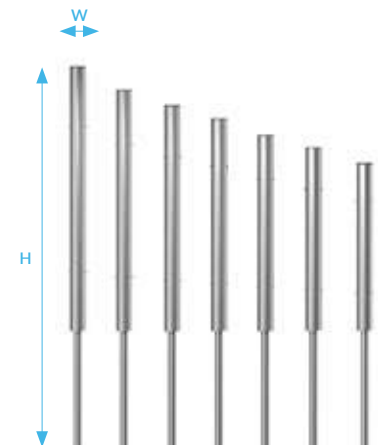
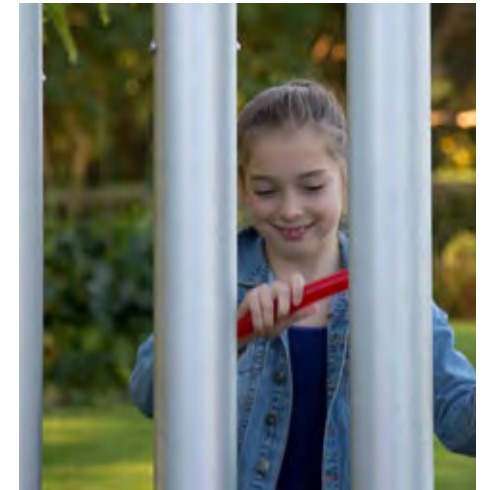

Weight 59 kg / 130 lbs  
Width 10 cm / 4 in  
Min Height 160 cm / 63 in  
Max Height 220 cm / 87 in



Our outdoor Marimba is big enough for up to four people to come together and play at any time.

This Marimba offers an enjoyable and exciting way to explore music-making and is great for improvised play and performances.

Tuned diatonically to C Major C3-C5 scale, when hit with the attached mallets, the Marimba makes a mellow, rich sound.

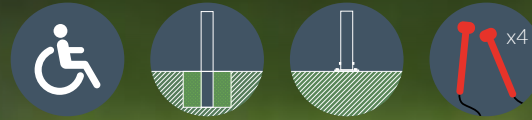

# Marimba

C Major Diatonic - C3-C5

Weight	57 kg / 126 lbs
Width	157 cm / 62 in
Depth	93 cm / 37 in
Max Height	86cm / 34in



# Akadinda

C Major Pentatonic - A2-D5

Weight 40 kg / 88 lbs  
Width 183 cm / 72 in  
Depth 122 cm / 48 in  
Max Height 112 cm / 44 in

A traditional African marimba inspired our Akadinda.

This 'gentle giant' of an instrument can accommodate up to four players and is ideal for bringing people together.

Made from Padauk hardwood, the notes or keys produce a natural, mellow tone that can be enjoyed by children and adults alike.

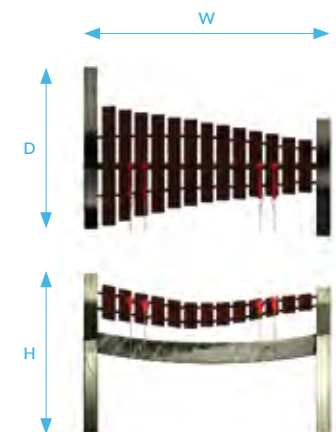

Producing an intense, deeply resonant sound, this substantial outdoor instrument is perfect as creative playground equipment, for music lessons or music therapy sessions.

The big wooden Padauk keys are reassuringly simple to play, making the Grand Marimba ideal for improvising and experimenting with music in the fresh air.

Set within a contemporary stainless-steel frame, it is suitable for ground or surface fixing.



# Grand Marimba

C Major Pentatonic - C3-C5

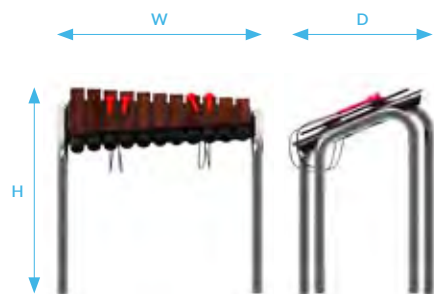
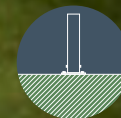
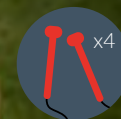

Weight	50 kg / 110 lbs
Width	131 cm / 52 in
Depth	102 cm / 40 in
Height	105 cm / 41 in

# Tembos

C Major Pentatonic - C3-C4

C Major Diatonic - C3-C4

Blues Scale - G, Bb, C, Eb, F, Gb, G

## Pentatonic

Weight 65 kg / 143 lbs

Depth 48 cm / 19 in

Width 58 cm / 23 in

Height 268 cm / 105 in

## Diatonic

Weight 85 kg / 187 lbs

Depth 48 cm / 19 in

Width 80 cm / 31 in

Height 268 cm / 105 in

## Blues

Weight 80 kg / 176 lbs

Depth 48 cm / 19 in

Width 70 cm / 27 in

Height 362 cm / 143 in



Pentatonic

Quirky and intriguing with a great sound to match, our range of plusive aerophones called Tembos are made of stainless-steel tubing.

Tembos (Swahili for elephant) produce bouncy, exciting sounds when the ends of the 'trunks' are hit with the EVA foam paddles.

Available in three different tunings; Pentatonic for easy improvisation with no clashing or dissonant notes, Diatonic so players can play familiar or favorite tunes as well as improvising or composing their own and finally Blues Scale which produces a very familiar deep bluesy sound.

Diatonic

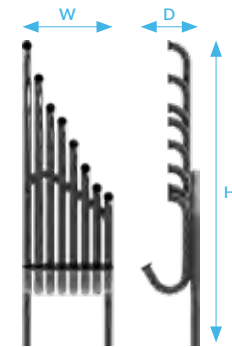

Blues

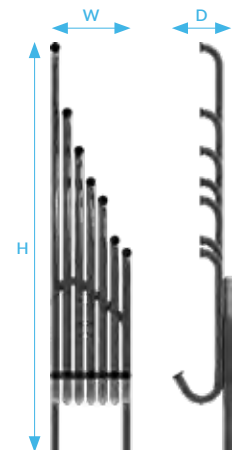

Pentatonic

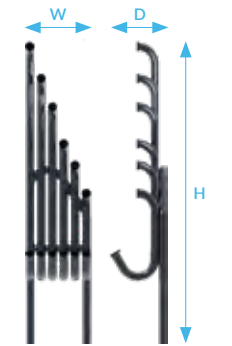

Our Handpipes are another example of 'plosive' aerophones designed to be played with the hands as the name suggests, to create a funky sound.

The diatonic tuning allows access to hundreds of tunes, allowing the player to improvise and experiment to their heart's content.

A high-density polyethylene (HDPE) mounting sets and aligns the instrument, so once installed all that's left to do is play!

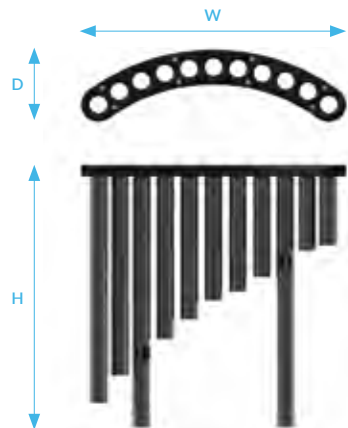

Weight	40 kg / 88 lbs
Width	91 cm / 36 in
Depth	25 cm / 10 in
Max Height	96 cm / 38 in

# Handpipes

C Major Diatonic - G3-C5



# Stepping Stones

Chords available: C Major, F Major  
G Major, D Minor, E Minor, A Minor



Stepping Stones offer a budget-friendly low-profile way to add a little musical fun to your play area.

Each square Stepping Stone hides a musical chord beneath it which is easily activated by a step, jump, or wheel across its top.

Stepping Stones use the same technology as our Floor Pianos but with each 'note' hiding an uplifting major or minor chord of three bells. Players can have fun discovering each bell by stepping on different spots – or jumping with both feet to play the chord. Each 'bell' - when struck - emits a pure tone with a long sustain and the sound intensifies the harder you jump!



Weight	30 kg / 66 lbs
Width	46 cm / 18 in
Depth	45 cm / 18 in
Height	14.5 cm / 6 in

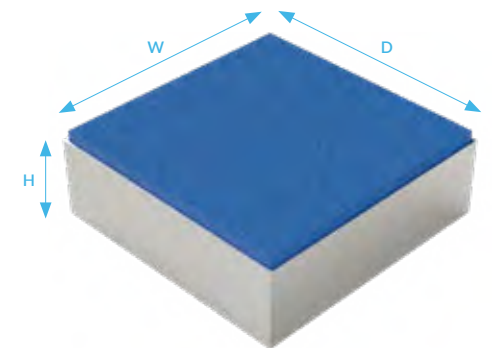

High energy and engaging, these fully chromatic mechanical floor pianos with sub-surface bells create clear and distinctive chimes on impact.

Available as a thirteen or twenty-five note instrument, it is sure to bring a smile to your face - especially if you've seen the Tom Hanks movie 'Big'!

Our Floor Piano is constructed from stainless-steel and aluminum and is designed to be installed completely level with the ground for safety and easy use in schools, parks and other public spaces. The Floor Piano is engineered to suit all environments.

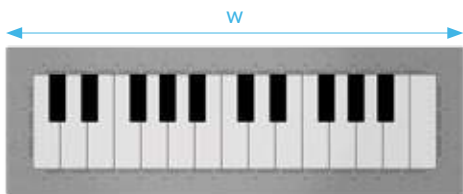
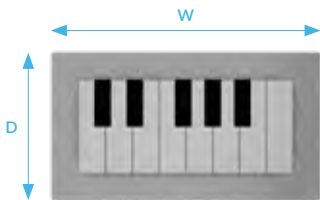

# Floor Piano

Baby - Chromatic C5-C6  
Grand - Chromatic C5-C7



## Grand Piano

Weight 660 kg / 1500 lbs  
Width 340 cm / 134 in  
Depth 110 cm / 43 in

## Baby Piano

Weight 330 kg / 725 lbs  
Width 200 cm / 79 in  
Depth 110 cm / 43 in

# Rainbow Trio Ensemble

C5-C6



The design and performance of our Rainbow Trio Ensemble are not compromised by size. Using the same high-quality materials, this little Trio easily matches the sound and durability found in our full-sized instruments, just on a smaller scale.



The trio creates a safe musical haven for exploring new sounds in the fresh air. You can even bring the outdoors in by installing the instruments to a wall indoors.



Bright and inviting, this ensemble is perfect for smaller establishments such as nursery schools, pre-schools, and kindergartens. Also ideal for music exhibits in children's museums and family-friendly attractions.





A small ensemble with a big impact! This popular trio only actually features three instruments yet it can still accommodate up to six players.

The set consists of seven Tubular Bells, a large Babel Drum and the anchor of rhythm, the Rainbow Sambat. With a variety of pitch, range and tonal character, everyone is sure to have their favorite piece.

# Trio Ensemble

A3-C6

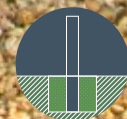

# Soprano Quartet Ensemble

C4-C6

The perfect choice for those projects where you need to squeeze the most out of your budget and create a resounding impact.

This mixed quartet of instruments comprises our compact but punchy Cadenza, a Babel Drum and Soprano Pentatonic Freechimes. Spanning two octaves from middle C to C6, players will be making harmonious music together almost instantly. The set also includes a pair of Congas to help keep a steady beat going.



The Alto Quartet is the bigger sibling to the Soprano Quartet Ensemble. An ideal solution for when you've got more space to play with and a little more budget.

This quartet consists of the Duo Cupla - offering both aluminum and GRP notes, a towering set of three Emperor Chimes, our Alto Diatonic Freechimes and a complete Congas Trio.

# Alto Quartet Ensemble

C3-C6



# Quintet Ensemble

A2-C6

The Quintet Ensemble of musical instruments offers a well-rounded range of tones and resonance. Anyone can take the stage and play improvised music with no tuition or acknowledged musical ability.

This popular collection provides a varied range of tones and sounds that blend effortlessly into beautiful music. This set consists of Cherub, Sansa-Rimba, the warming Akadinda, a set of seven Tubular Bells and the Rainbow Sambas.



The Street Quartet is designed for the toughest environments. Elements of 316 stainless-steel, aluminum and HDPE combine for ultimate durability in areas of high use. All instruments are played with hands only (no mallets) and the set consists of a Large Babel Drum, Handpipes, Emperor Chimes and Cajon Drum.

# Street Quartet

C3-C5



# Talk Tubes

Weight	50 kg / 110 lbs
Width	26 cm / 10 in
Depth	59 cm / 23 in
Height (L)	141 cm / 56 in
Height (S)	110 cm / 44 in



Made from stainless-steel, our Talk Tubes allow children to communicate across their playground, encouraging co-operative and imaginative play and social interaction.

Children will delight as they whisper into one of the large stainless-steel sound cones, and their friend, sibling or classmate receives their secret message on the other side of the playground!

Available as standard with 12m/40ft of piping (which can be extended to up to 60m/197ft).

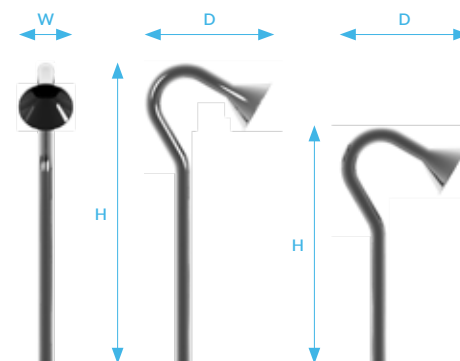

# In Loving Memory

Remembering and celebrating the lives of the people we have lost helps us move through the stages of grief and pay our respects to those who live on in our memories. Music is a wonderful celebration of life and a musical memorial in the great outdoors will bring harmony and light into the lives of others whilst creating something beautiful to honor a memory.

A musical instrument or musical space for the community to enjoy could be the perfect way to pay tribute to a loved one who loved music, loved the outdoors, or had a playful and adventurous spirit.

From large music parks to small sensory gardens, from a single drum to a collection of rainbow-colored instruments: we have worked with families and organizations who turned to music to keep the memory of someone special alive in a unique and joyful way.

Outdoor musical instruments can be installed in numerous locations outdoors including memorial gardens, quiet spaces in the grounds of hospitals and hospices, school grounds, museums, libraries and churches.

For instruments purchased as memorials, we are pleased to offer an appropriate engraving on request, free of charge.

*“ Music always played a really big part in her life. She was always moved by music and listened to music throughout her treatment. ”*



*"We are extremely happy with the instruments and our children love them... I would be happy to recommend Percussion Play to anyone looking to buy outdoor musical instruments. The quality of the instruments is excellent and the customer service was outstanding."*

Deb Winn, Program Coordinator at the Children's Healing Center, Grand Rapids, Michigan

*"I want to thank you for your amazing instruments that have transformed our sensory area and helped create a truly inclusive sensory experience, for young and old alike, regardless of abilities... Without exception your instruments have brought a little magic and joy to everyone who has walked through the gates of our playground."*

Niamh Egan - Chair of Greystones Playground Committee Ireland. Greystones, Co Wicklow, Ireland

*"The drums, vibraphone and tonal chimes have been met with massive excitement from the whole community. People are going to the park now specifically to check out these instruments! Not only are they colourful and accessible, the quality of the instruments is outstanding, meaning they make a fantastic sound."*

Anna Moore - NZ Registered Music Therapist  
Nelson, Marlborough & Tasman, New Zealand

UK: 01730 235180  
USA/CAN: +1 (866) 882-9170  
RoW: +44 1730 235180

Global Sales & Manufacturing  
Percussion Play Ltd

[info@percussionplay.com](mailto:info@percussionplay.com)

[www.percussionplay.com](http://www.percussionplay.com)



[app.percussionplay.com](http://app.percussionplay.com)